

REVOLVING CENTERING TAPER

For counter-clamping workpieces with large boreholes, (e.g. pipes) on turning and grinding machines, in one set-up. The centre point of the revolving centering taper from RÖHM is hardened and ground for maximum wear resistance.

REVOLVING CENTERING TAPER



- ⊕ Large clamping range for a wide range of boreholes and centres
- ⊕ Robust precision bearing for high axial and radial loads

REVOLVING CENTERING TAPER WITH INTERCHANGEABLE INSERTS



- ⊕ Maximum flexibility thanks to use of exchangeable centering taper attachments
- ⊕ Quick change of centering taper attachment in case of wear



APPLICATION

For counter-clamping workpieces with large boreholes, such as pipes on lathes and grinding machines.

TYPE

Revolving centering taper in pointed version or cone truncated version.

CUSTOMER BENEFITS

- ⊕ Large clamping range for a wide range of boreholes and centres
- ⊕ Proven 3-fold bearing for high axial and radial load

TECHNICAL FEATURES

- Body hardened and ground

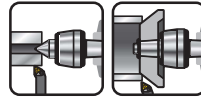

A06

Revolving centering taper, pointed, as revolving centre for tubular workpieces as well as centre for machining standard workpieces

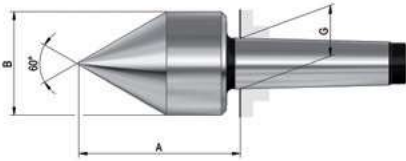

Item no.	Size	Mount MT	A mm	B mm	G mm	Workpiece weight max. kg	Concentricity deviation max. mm	Speed max. min ⁻¹	Weight g
010613	272	2	61	42	17,78	200	0,01	6000	400
010635	273	3	79	56	23,825	400	0,008	6000	1100
010638	274	4	100	64	31,267	800	0,008	4000	1600
010642	275	5	115,5	78	44,399	1600	0,008	4000	3600
306396	276	6	153	105	63,348	2500	0,008	2500	10000

A06

Revolving centering taper, cone truncated, 60°

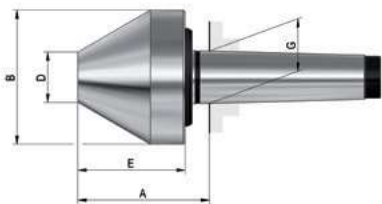

Item no.	Size	Mount MT	A mm	B mm	D mm	E mm	G mm	Work-piece weight max. kg	Concentricity deviation max. mm	Speed max. min ⁻¹	Weight g
301616	171a	2	65	50	20	52	17,78	200	0,008	6000	1200
301556	172	2	77	80	30	64	17,78	300	0,008	5000	2000
301557	172a	3	77	80	30	64	23,825	400	0,008	5000	2200
221605	173	3	96,5	120	30	83	23,825	600	0,008	4000	4200
301558	172b	4	78,5	80	30	64	31,267	400	0,008	5000	2300
044023	173a	4	98	120	30	83	31,267	800	0,008	4000	4500
090483	173b	5	99	120	30	83	44,399	800	0,008	4000	5300

A06

Revolving centering taper, cone truncated, 75°

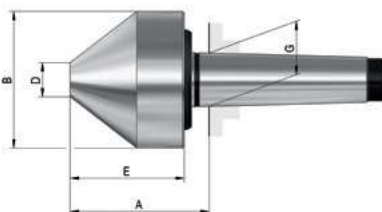

Item no.	Size	Mount MT	A mm	B mm	D mm	E mm	G mm	Work-piece weight max. kg	Concentricity deviation max. mm	Speed max. min ⁻¹	Weight g
301559	172	2	80	80	20	67	17,78	300	0,008	5000	2000
301560	172a	3	80	80	20	67	23,825	400	0,008	5000	2000
062211	173	3	85,5	120	30	72	23,825	600	0,008	4000	4200
301561	172b	4	81,5	80	20	67	31,267	400	0,008	5000	2400
062224	173a	4	87	120	30	72	31,267	800	0,008	4000	4300
062299	174	4	107	170	50	90	31,267	1200	0,01	2800	9700
062232	173b	5	88	120	30	72	44,399	800	0,008	4000	5100
063614	174a	5	106	170	50	90	44,399	1600	0,01	2800	10600
063662	175	5	146,5	250	75	130	44,399	2000	0,01	2200	34000
063633	174b	6	107,5	170	50	90	63,348	1600	0,01	2800	13300
063656	175a	6	148	250	75	130	63,348	2000	0,01	2200	37000
063680	176	6	184	350	120	168	63,348	4000	0,015	1200	82000



APPLICATION

For counter-clamping workpieces with large boreholes, such as pipes on lathes and grinding machines.

TYPE

With interchangeable centering taper attachments. Optionally with draw-off nut or fixed shaft.

CUSTOMER BENEFITS

- ☺ High flexibility thanks to interchangeable centering taper attachments
- ☺ Quick change of interchangeable centering taper attachments

TECHNICAL FEATURES

- Body hardened and ground
- Centering taper insert hardened and ground

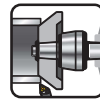

A06
Revolving centering taper

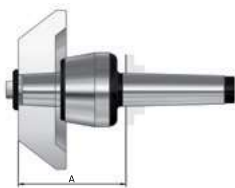

Item no.	Size	Mount MT	A mm	Workpiece weight max. kg	Concentricity deviation max. mm	Speed max. min ⁻¹	Weight g
304562	108	4	103	800	0,005	3800	2200
304563	110	5	128	1600	0,005	3000	4800
304564	114	6	159	3000	0,005	2600	12000

With fastening screw and disc, without centering taper attachment
Concentricity deviation measured at conical mount

A06
Revolving centering tapers with draw-off nut, for high load

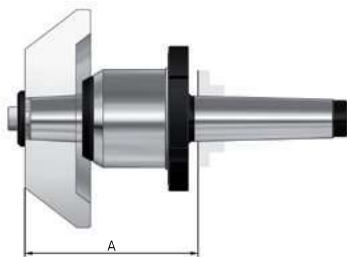

Item no.	Size	Mount MT	A mm	Workpiece weight max. kg	Concentricity deviation max. mm	Speed max. min ⁻¹	Weight g
304583	494	4	118	1000	0,005	7000	3200
304584	495	5	140	2000	0,005	6000	6500
304585	496	6	168	3500	0,005	4800	13500

With fastening screw and disc, without centering taper attachment
Concentricity deviation measured at conical mount

A07
Fixed shafts



Item no.	Mount MT	A mm	Workpiece weight max. kg	Concentricity deviation max. mm	Weight g
304580	4	45	2000	0,003	800
304581	5	60	4800	0,003	2000
304582	6	70	12000	0,003	5500

With fastening screw and disc, without centering taper attachment
Version with draw-off nut on request
Concentricity deviation measured at conical mount

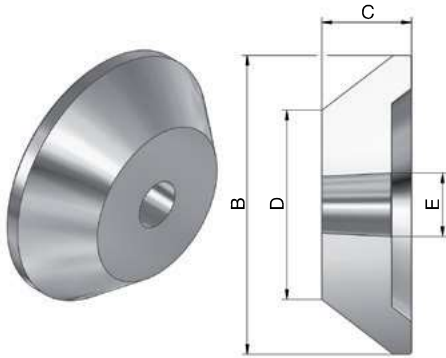

Item no.	Size	for MT	B mm	C mm	D mm	E mm	Weight g
304565 ¹⁾	1	4	60	68	5	32	900
304566	2	4	100	45	45	32	1500
304567	3	4	150	45	95	32	4100
304568	4	4	200	45	145	32	6000
304569	5	4	250	45	195	32	8500
304570	1	5	100	43	45	40	1500
304571	2	5	150	43	95	40	4400
304572	3	5	200	43	145	40	6100
304573	4	5	250	43	195	40	8100
304574	5	5	300	43	245	40	11600
304575	1	6	150	54	95	50	3000
304576	2	6	200	54	145	50	8100
304577	3	6	250	54	195	50	11100
304578	4	6	300	54	245	50	14000
304579	5	6	350	54	295	50	18800

¹⁾ Without fixing by screw and washer